

ELETTRODI

Elettrodi per puntatrici cono $\varnothing 20$ con. 10%

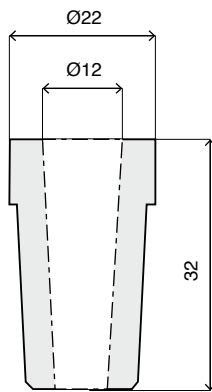

20804

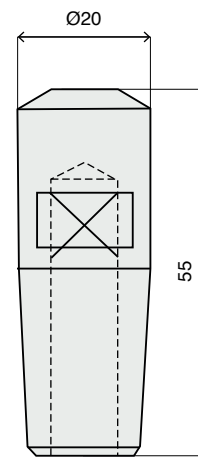

20805

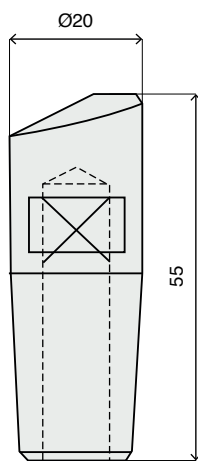

20806

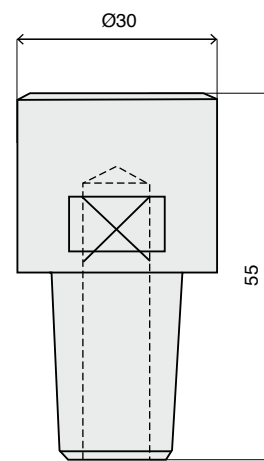

20807

ELETTRODI

Elettrodi per cucitrici cono $\varnothing 20$ con. 10% - rame cobalto berillio al 2%

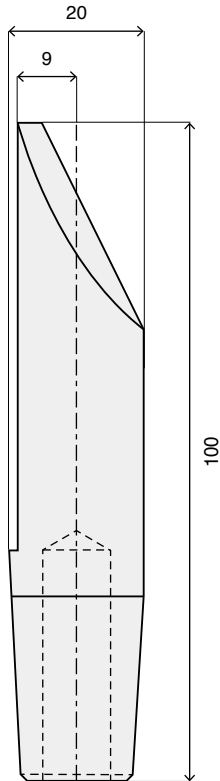

20801

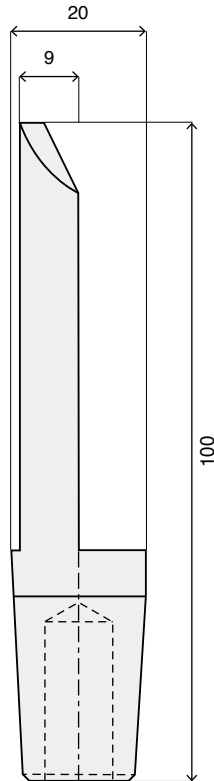

20802

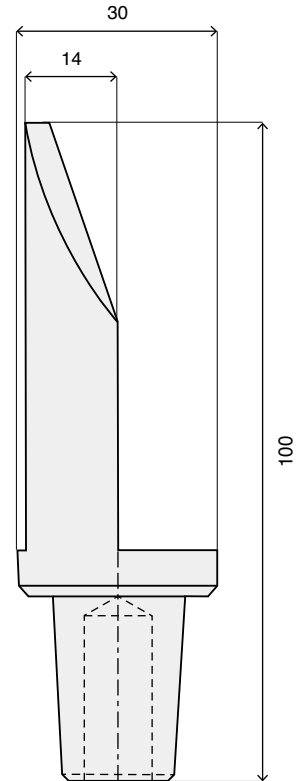

20803

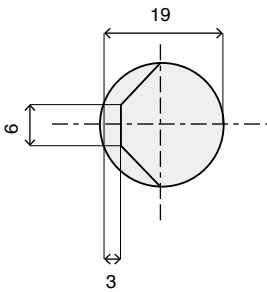

20801

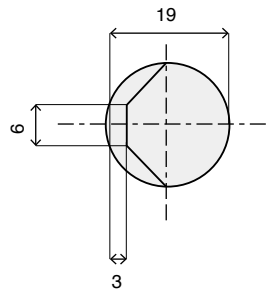

20802

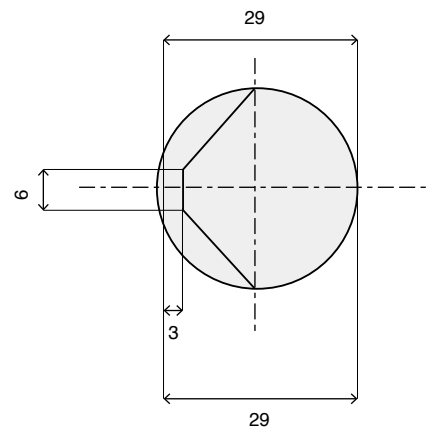

20803