

ELETTRODI

Elettrodi per puntatrici cono \varnothing 12 con. 10%

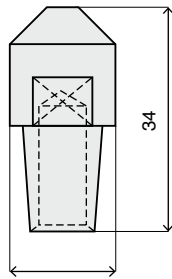

$\varnothing 16$

12401

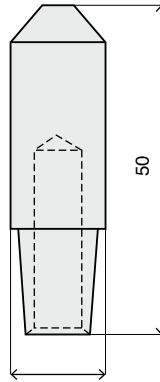

$\varnothing 14$

12402

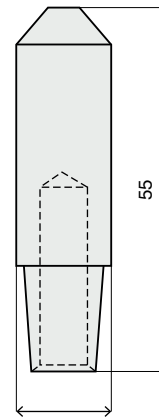

$\varnothing 14$

12403

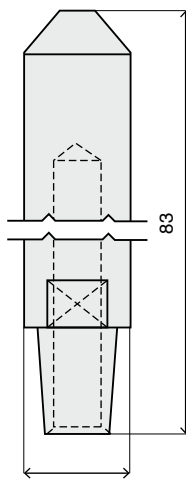

$\varnothing 16$

12404

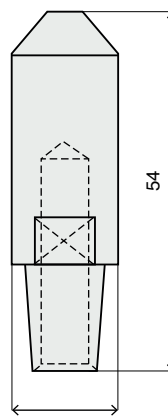

$\varnothing 16$

12405

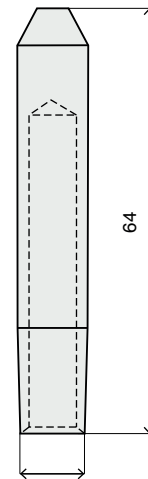

$\varnothing 12$

12406

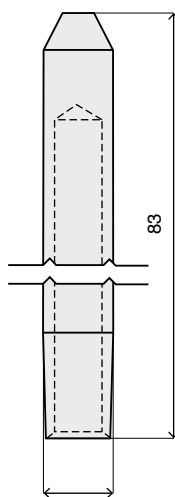

$\varnothing 12$

12407

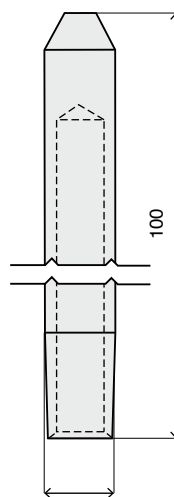

$\varnothing 12$

12408

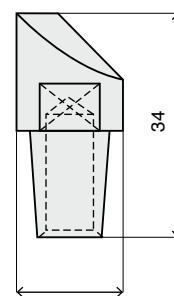

$\varnothing 16$

12409

ELETTRODI

Elettrodi per puntatrici cono \varnothing 12 con. 10%

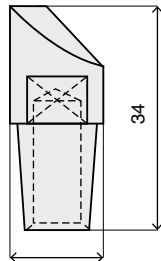

\varnothing 14
12410

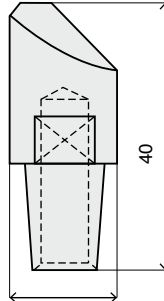

\varnothing 16
12411

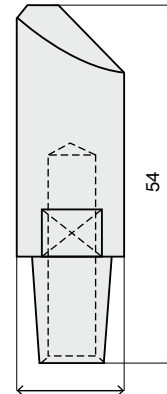

\varnothing 16
12412

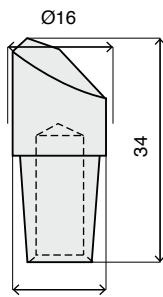

\varnothing 16
 \varnothing 14
12413

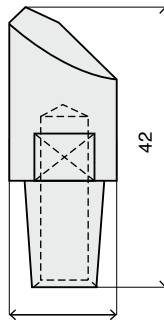

\varnothing 16
12414

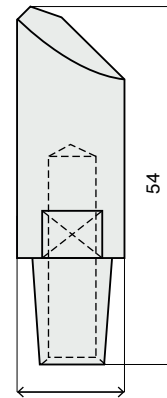

\varnothing 16
12415

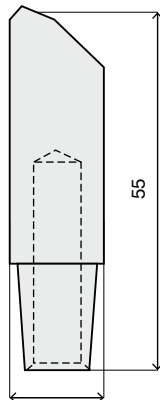

\varnothing 14
12416

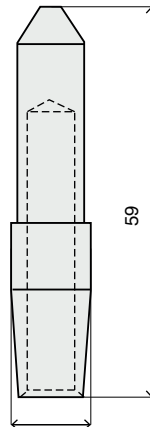

\varnothing 12
12417

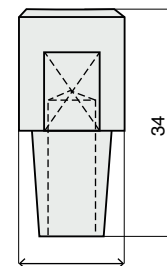

\varnothing 16
12418

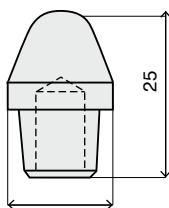

\varnothing 16
100008

ELETTRODI

Elettrodi per puntatrici cono \varnothing 12 con. 10%

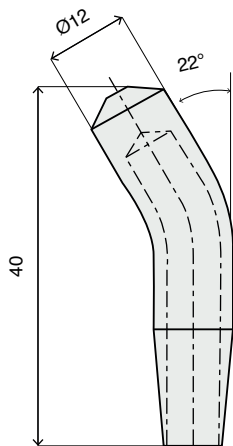

12424

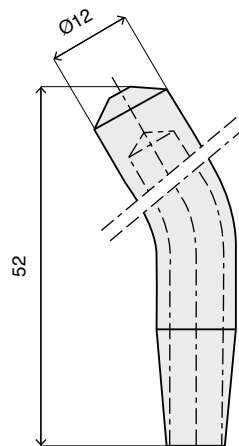

12425

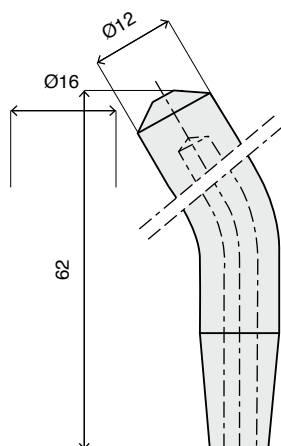

12426

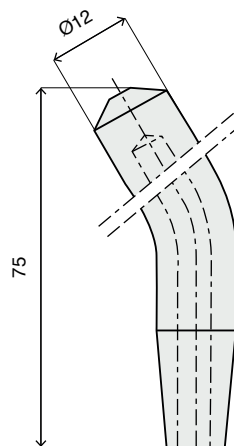

12427

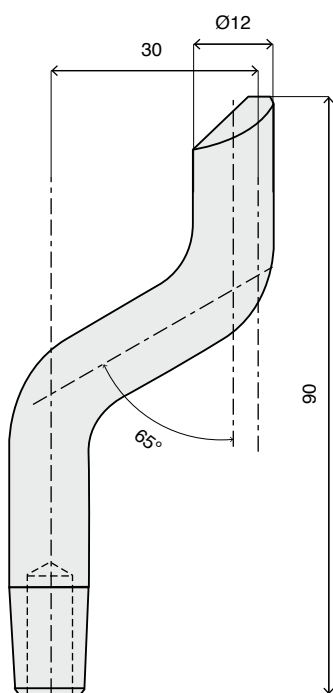

12431

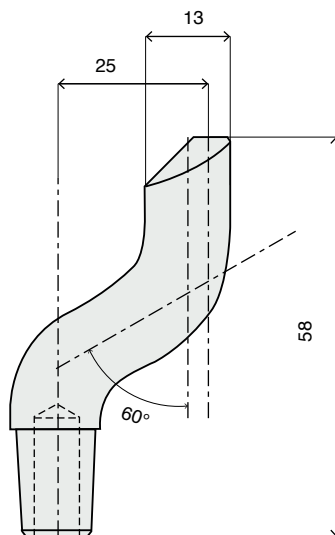

12427S

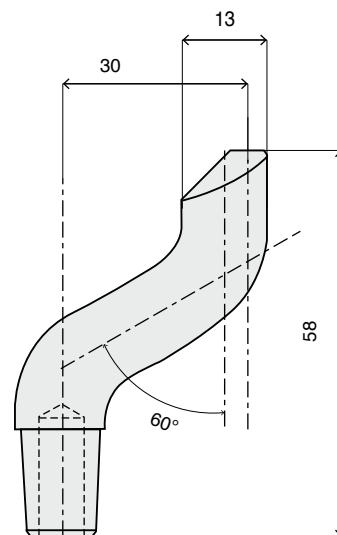

12428