

## ELETTRODI

Elettrodi per puntatrici cono  $\varnothing$  12 con. 10%

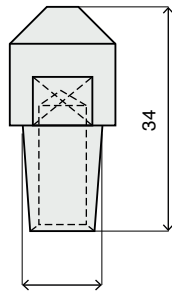

$\varnothing$ 16  
12401

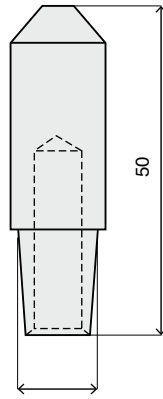

$\varnothing$ 14  
12402

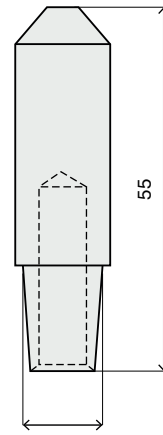

$\varnothing$ 14  
12403

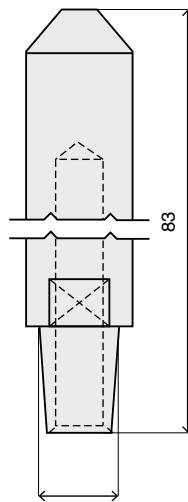

$\varnothing$ 16  
12404

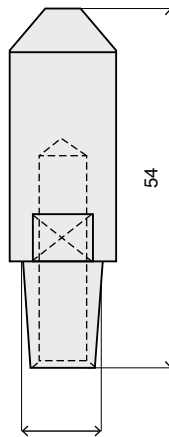

$\varnothing$ 16  
12405

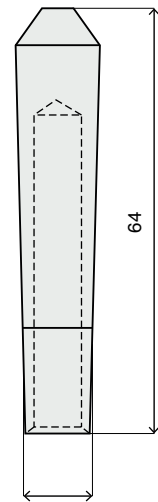

$\varnothing$ 12  
12406

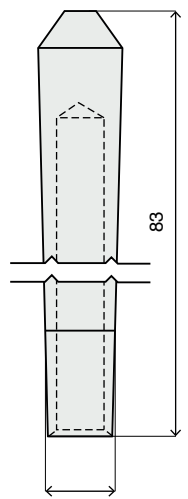

$\varnothing$ 12  
12407

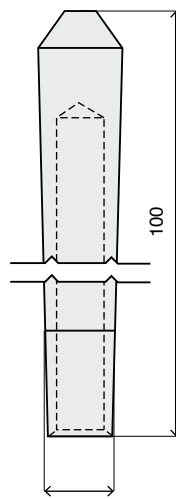

$\varnothing$ 12  
12408

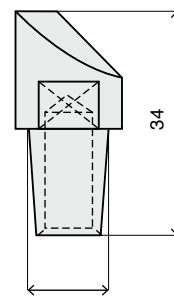

$\varnothing$ 16  
12409

## ELETTRODI

Elettrodi per puntatrici cono  $\varnothing$  12 con. 10%

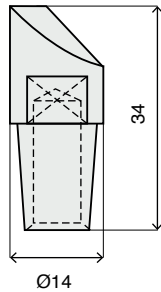

$\varnothing$ 14  
12410

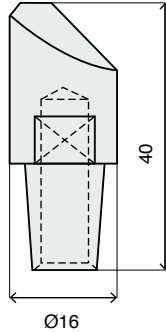

$\varnothing$ 16  
12411

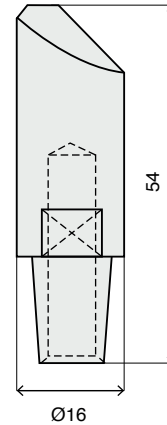

$\varnothing$ 16  
12412

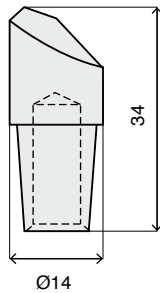

$\varnothing$ 14  
12413

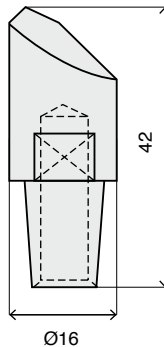

$\varnothing$ 16  
12414

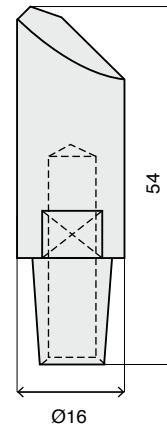

$\varnothing$ 16  
12415

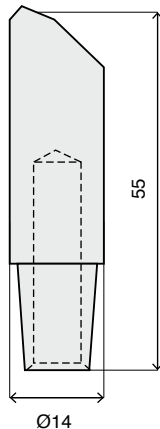

$\varnothing$ 14  
12416

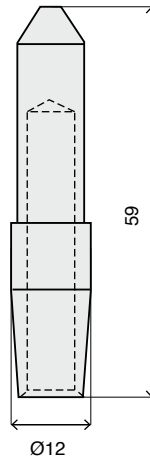

$\varnothing$ 12  
12417

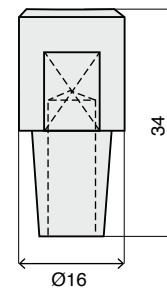

$\varnothing$ 16  
12418

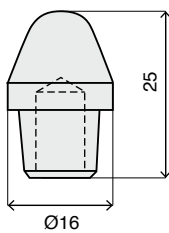

$\varnothing$ 16  
10008

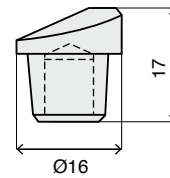

$\varnothing$ 16  
17

## ELETTRODI

Elettrodi per puntatrici cono  $\varnothing 12$  con. 10%

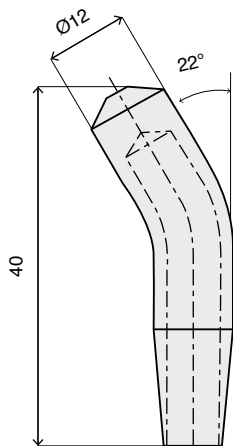

12424

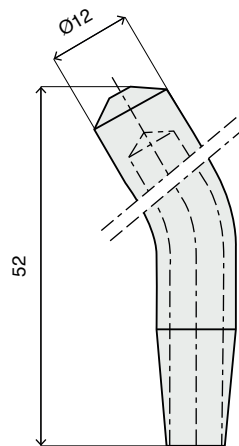

12425

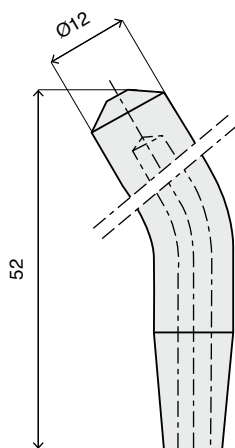

12426

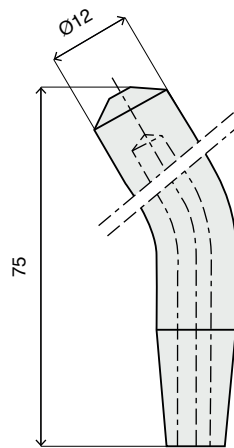

12427

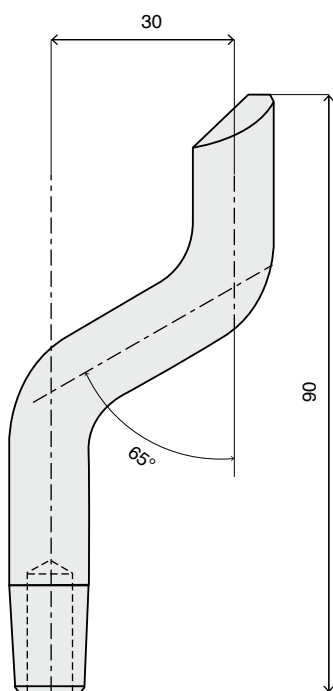

12431

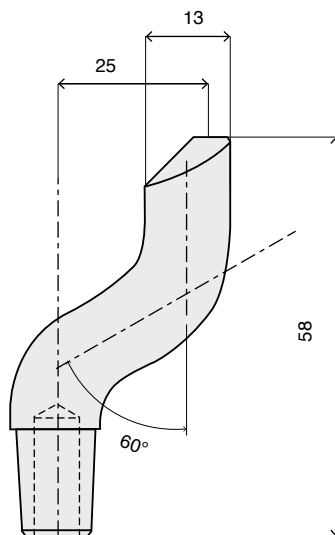

12427S

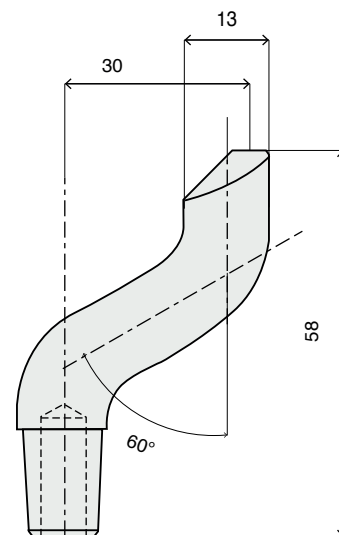

12428